



1A Low Dropout Positive Adjustable or Fixed-Mode Regulator

■ Features

- 1.5V maximum dropout at full load current
- Fast transient response
- Output current limiting
- Built-in thermal shutdown
- Packages: SOT223, TO252, SOT89,
- Good noise rejection
- 3-Terminal Adjustable or Fixed 1.5V, 1.8V, 1.9V, 2.5V, 3.3V, 5.0V
- Halogen Free & RoHS Compliant product

■ General Description

APE1117 is a low dropout positive adjustable or fixed-mode regulator with minimum of 1A output current capability. The product is specifically designed to provide well-regulated supply for low voltage IC applications such as high-speed bus termination and low current 3.3V logic supply. APE1117 is also well suited for other applications such as VGA cards. APE1117 is guaranteed to have lower than 1.5V dropout at full load current making it ideal to provide well-regulated outputs of 1.25 to 5.0 with 6.4V to 16V input supply.

■ Applications

- PC peripheral
- Communication

■ Ordering Information

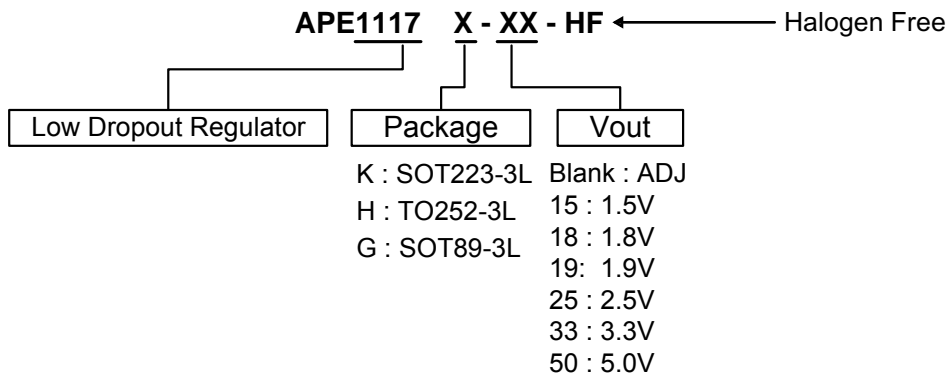

■ Typical Circuit

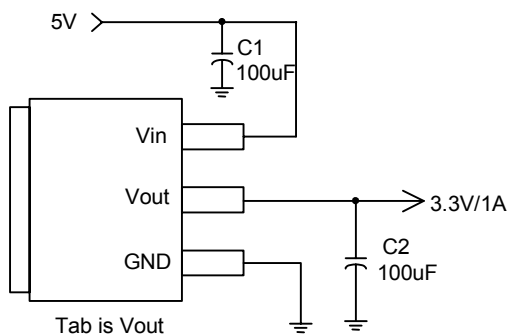

(5V/3.3V fixed output)

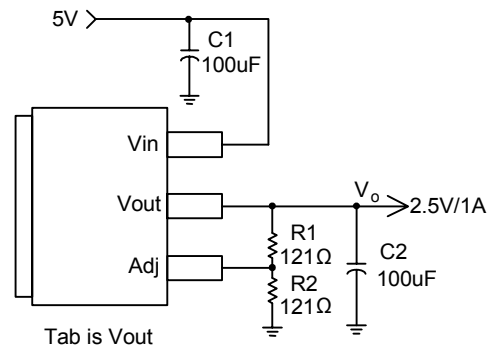

(5V/2.5V ADJ output)

Note: $V_o = V_{REF} * (1 + \frac{R_2}{R_1})$



1A Low Dropout Positive Adjustable or Fixed-Mode Regulator

■ Connection Diagram

3 PIN SOT223

(Top View)



Tab is Vout

3 PIN TO252

(Top View)

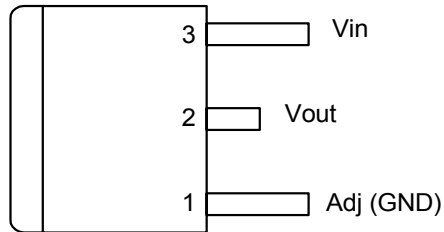

Tab is Vout

3 PIN SOT89

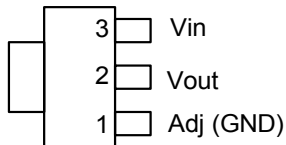

Tab is Vout

■ Block Diagram

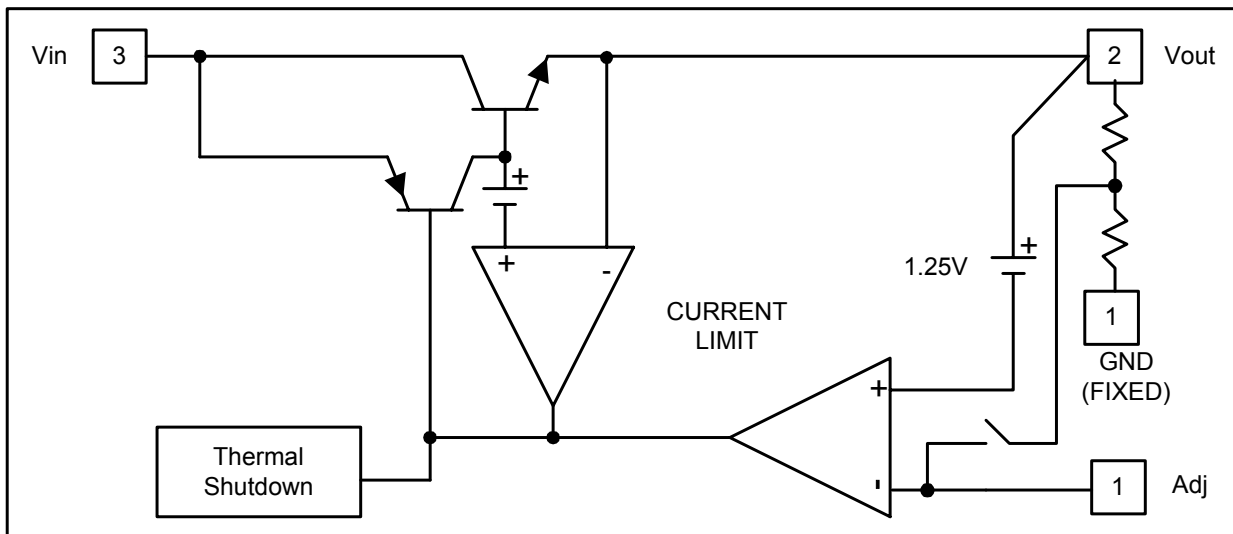



1A Low Dropout Positive Adjustable or Fixed-Mode Regulator

■ **Pin Descriptions**

NAME	I/O	PIN #	FUNCTION
Adj (GND)	I	1	A resistor divider from this pin to the Vout pin and ground sets the output voltage. (Ground only for Fixed-Mode)
Vout	O	2	The output of the regulator. A minimum of 10uF capacitor ($0.15\Omega \leq \text{ESR} \leq 1\Omega$) must be connected from this pin to ground to insure stability.
Vin	I	3	The input pin of regulator. Typically a large storage capacitor ($0.15\Omega \leq \text{ESR} \leq 1\Omega$) is connected from this pin to ground to insure that the input voltage does not sag below the minimum dropout voltage during the load transient response. This pin must always be 1.3V higher than Vout in order for the device to regulate properly.

■ **Absolute Maximum Ratings**

Symbol	Parameter	Rating	Unit
Vin	DC Supply Voltage	-0.3 to 16	V
<u>P_D</u>	Power Dissipation	Internally Limited	
<u>T_{ST}</u>	Storage Temperature	-65 to +150	°C
T _{OP}	Operating Junction Temperature Range	0 to +150	°C



1A Low Dropout Positive Adjustable or Fixed-Mode Regulator

■ Electrical Characteristics (Under Operating Conditions)

PARAMETER	CONDITIONS		MIN	TYP	MAX	UNIT
Reference Voltage	APE1117-ADJ	$T_J=25^{\circ}\text{C}, (V_{\text{IN}}-V_{\text{OUT}})=1.5\text{V}$ $I_O=10\text{mA}$	1.225	1.250	1.275	V
Output Voltage	APE1117-15	$I_{\text{OUT}} = 10\text{mA}, T_J = 25^{\circ}\text{C},$ $3\text{V } V_{\text{IN}} 16\text{V}$	1.470	1.500	1.530	V
	APE1117-18	$I_{\text{OUT}} = 10\text{mA}, T_J = 25^{\circ}\text{C},$ $3.3\text{V } V_{\text{IN}} 16\text{V}$	1.764	1.800	1.836	V
	APE1117-19	$I_{\text{OUT}} = 10\text{mA}, T_J = 25^{\circ}\text{C},$ $3.3\text{V } V_{\text{IN}} 16\text{V}$	1.862	1.900	1.938	V
	APE1117-25	$I_{\text{OUT}} = 10\text{mA}, T_J = 25^{\circ}\text{C},$ $4\text{V } V_{\text{IN}} 16\text{V}$	2.450	2.500	2.550	V
	APE1117-33	$I_{\text{OUT}} = 10\text{mA}, T_J = 25^{\circ}\text{C},$ $4.8\text{V } V_{\text{IN}} 16\text{V}$	3.235	3.300	3.365	V
	APE1117-50	$I_{\text{OUT}} = 10\text{mA}, T_J = 25^{\circ}\text{C},$ $6.5\text{V } V_{\text{IN}} 16\text{V}$	4.900	5.000	5.100	V
Line Regulation	APE1117-XXX	$I_O=10\text{mA}, V_{\text{OUT}}+1.5\text{V}<V_{\text{IN}}<16\text{V},$ $T_J=25^{\circ}\text{C}$			0.5	%
Load Regulation	APE1117-ADJ	$V_{\text{IN}}=3.3\text{V}, V_{\text{adj}}=0, 10\text{mA}<I_O<1\text{A},$ $T_J=25^{\circ}\text{C}$ (Note 1,2)			1	%
	APE1117-15	$V_{\text{IN}}=3\text{V}, 10\text{mA}<I_O<1\text{A},$ $T_J=25^{\circ}\text{C}$ (Note 1,2)		12	15	mV
	APE1117-18	$V_{\text{IN}}=3.3\text{V}, 10\text{mA}<I_O<1\text{A},$ $T_J=25^{\circ}\text{C}$ (Note 1,2)		15	18	mV
	APE1117-19	$V_{\text{IN}}=3.3\text{V}, 10\text{mA}<I_O<1\text{A},$ $T_J=25^{\circ}\text{C}$ (Note 1,2)		16	19	mV
	APE1117-25	$V_{\text{IN}}=4\text{V}, 10\text{mA}<I_O<1\text{A},$ $T_J=25^{\circ}\text{C}$ (Note 1,2)		20	25	mV
	APE1117-33	$V_{\text{IN}} = 5\text{V}, 10\text{mA } I_{\text{OUT}} 1\text{A},$ $T_J=25^{\circ}\text{C}$ (Note 1,2)		26	33	mV
	APE1117-50	$V_{\text{IN}} = 6.5\text{V}, 10\text{mA } I_{\text{OUT}} 1\text{A},$ $T_J=25^{\circ}\text{C}$ (Note 1,2)		40	50	mV
Dropout Voltage ($V_{\text{IN}}-V_{\text{OUT}}$)	APE1117-ADJ/15/18 /19/25/33/50	$I_{\text{OUT}} = 1\text{A}, \Delta V_{\text{OUT}}=1\%V_{\text{OUT}}$		1.3	1.5	V
Current Limit	APE1117-ADJ/15/18 /19/25/33/50	$(V_{\text{IN}}-V_{\text{OUT}}) = 5\text{V}$	1.1			A
Minimum Load Current	APE1117-XXX	$0^{\circ}\text{C } T_J 125^{\circ}\text{C}$		5	10	mA
Thermal Regulation	$T_A=25^{\circ}\text{C}, 30\text{ms pulse}$			0.008	0.04	%/W
Ripple Rejection	$F=120\text{Hz}, C_{\text{OUT}}=25\mu\text{F Tantalum}, I_{\text{OUT}}=1\text{A}$					
	APE1117-XXX	$V_{\text{IN}}=V_{\text{OUT}}+3\text{V}$		60	70	dB
Temperature Stability	$I_O=10\text{mA}$			0.5		%
Thermal Shutdown Temperature				150		
Thermal Shutdown Temperature Recovery				130		
θ_{JA} Thermal Resistance Junction-to-Ambient(No heat sink ;No air flow)	SOT89			300		$^{\circ}\text{C/W}$
	SOT-223			117		
	TO-252			92		
θ_{JC} Thermal Resistance Junction-to-Case	SOT89 : Control Circuitry/Power Transistor			100		$^{\circ}\text{C/W}$
	SOT-223 : Control Circuitry/Power Transistor			15		
	TO-252 : Control Circuitry/Power Transistor			10		

Note1: See thermal regulation specifications for changes in output voltage due to heating effects. Line and load regulation are measured at a constant junction temperature by low duty cycle pulse testing. Load regulation is measured at the output lead = 1/18" from the package.

Note2: Line and load regulation are guaranteed up to the maximum power dissipation of 15W. Power dissipation is determined by the difference between input and output differential and the output current. Guaranteed maximum power dissipation will not be available over the full input/output range.

Note3: Quiescent current is defined as the minimum output current required in maintaining regulation. At 12V input/output differential the device is guaranteed to regulate if the output current is greater than 10mA.



■ **Typical Performance Characteristics**

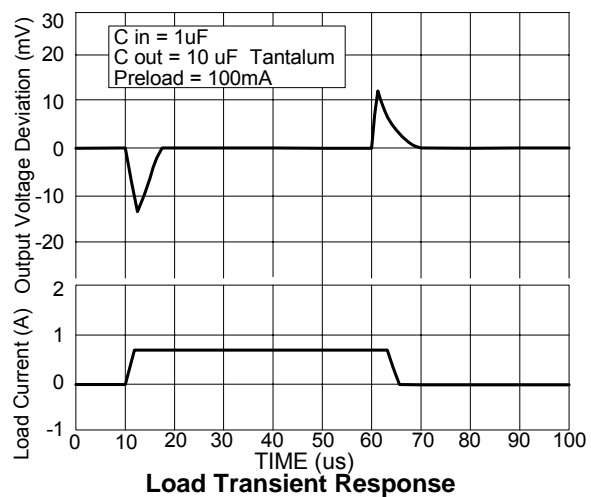
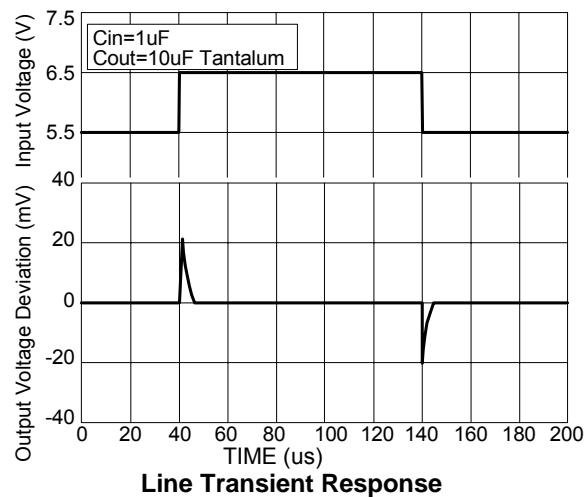
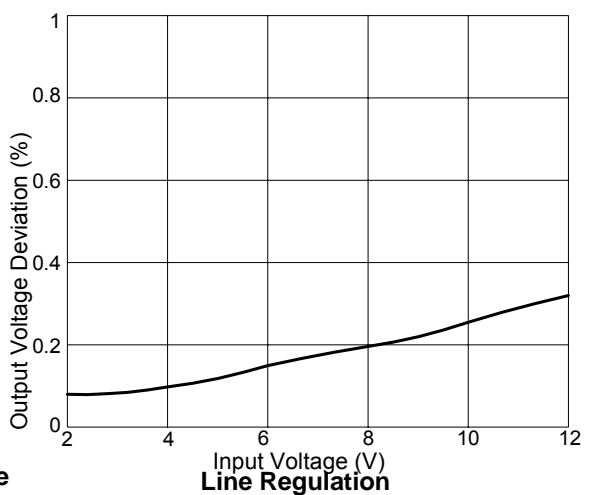
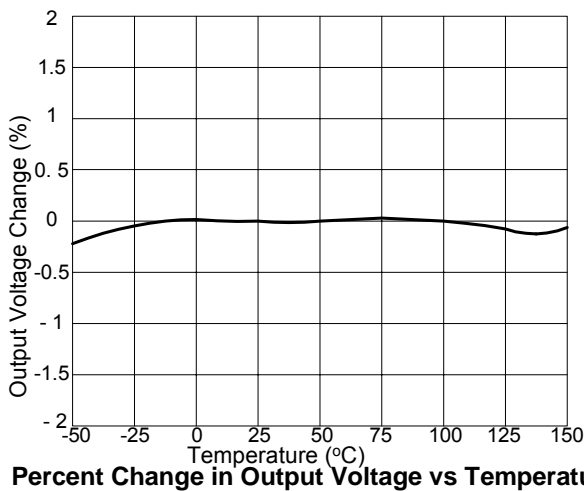
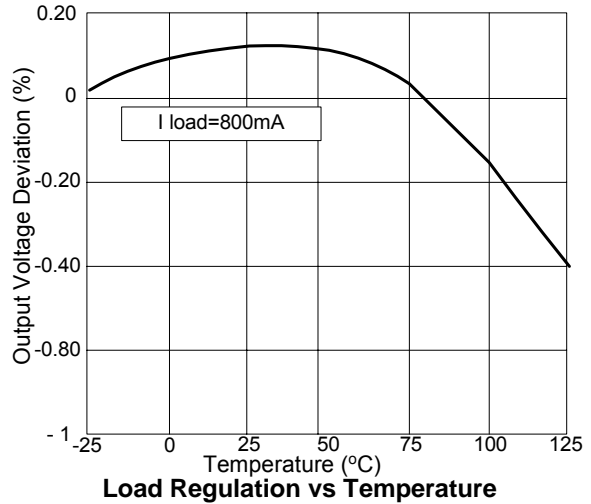
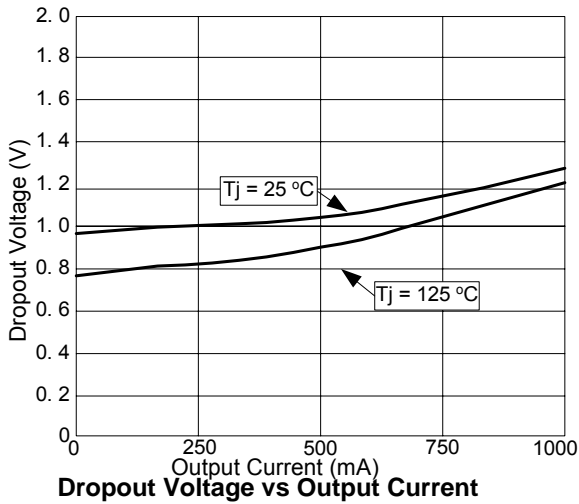



1A Low Dropout Positive Adjustable or Fixed-Mode Regulator

■ Marking Information

(1) SOT223-3L

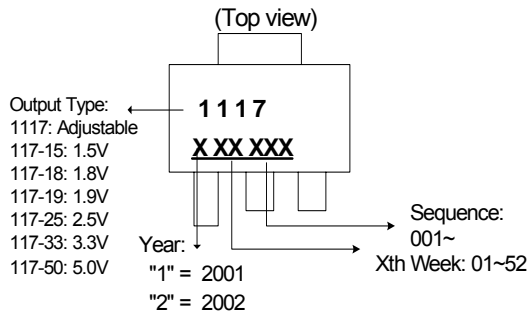

(2) TO252-3L

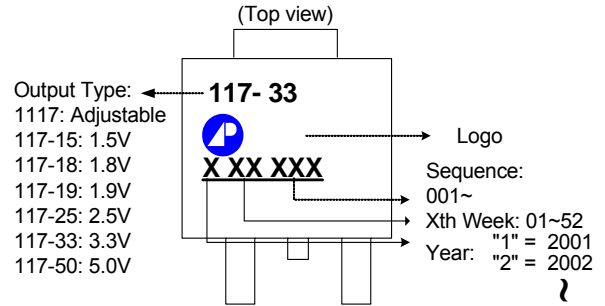

(3) SOT89-3L

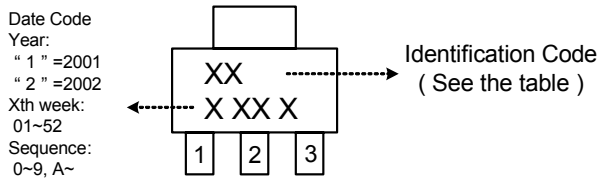

Identification code	Output version
EA	APE1117-ADJ
EB	APE1117-1.5V
EC	APE1117-1.8V
EG	APE1117-1.9V
ED	APE1117-2.5V
EE	APE1117-3.3V
EF	APE1117-5.0V



Package Outline : TO-252

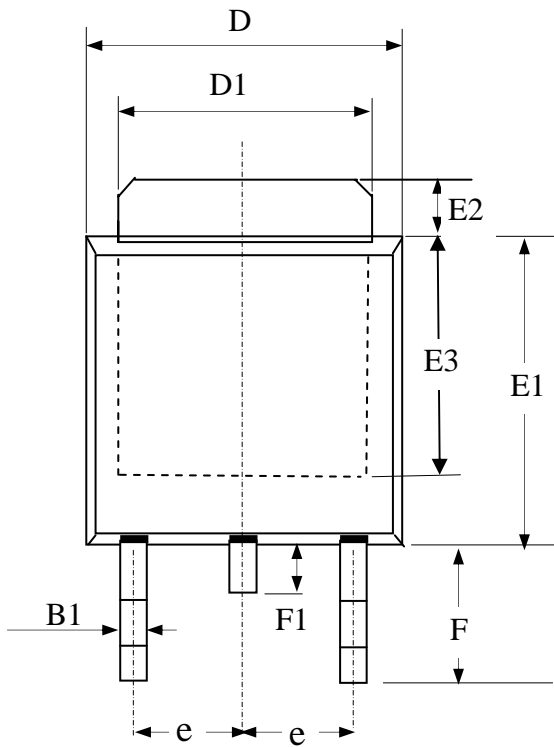

SYMBOLS	Millimeters		
	MIN	NOM	MAX
A2	1.80	2.30	2.80
A3	0.40	0.50	0.60
B1	0.40	0.70	1.00
D	6.00	6.50	7.00
D1	4.80	5.35	5.90
E3	3.50	4.00	4.50
F	2.20	2.63	3.05
F1	0.50	0.85	1.20
E1	5.10	5.70	6.30
E2	0.50	1.10	1.80
e	--	2.30	--
C	0.35	0.50	0.65

- 1.All Dimensions Are in Millimeters.
- 2.Dimension Does Not Include Mold Protrusions.

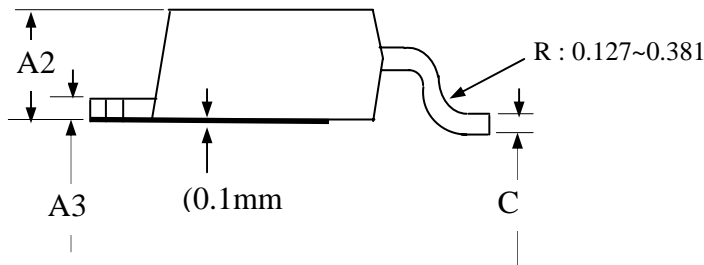

Part Marking Information & Packing : TO-252

Laser Marking

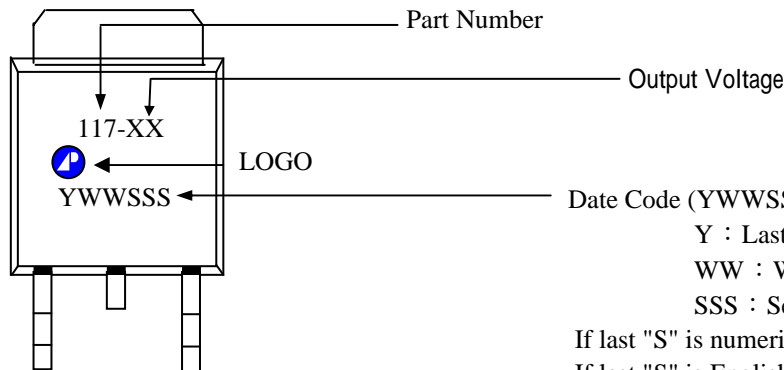

If last "S" is numerical letter : Rohs product
If last "S" is English letter : HF & Rohs product



Package Outline : SOT-223

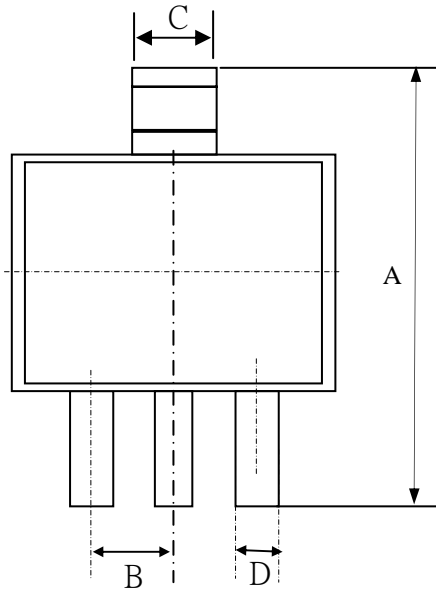

SYMBOLS	Millimeters		
	MIN	NOM	MAX
A	6.70	7.00	7.30
B	---	2.30	---
C	2.90	3.00	3.10
D	0.60	0.70	0.80
G	0.25	0.30	0.35
E	6.30	6.50	6.70
F	1.40	1.60	1.80
K	0.02	0.06	0.10

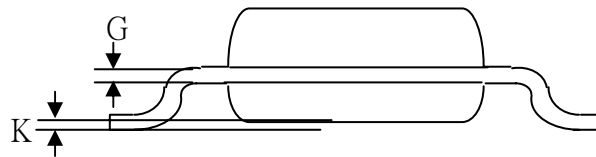
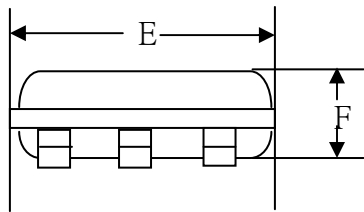

- 1.All Dimension Are In Millimeters.
- 2.Dimension Does Not Include Mold Protrusions.

Part Marking Information & Packing : SOT-223

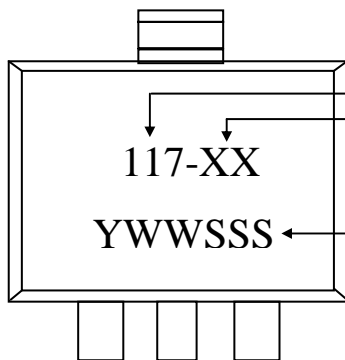

Part Number ——— Output Voltage

Date Code (YWWSSS)

Y : Last Digit Of The Year

WW : Week

SSS : Sequence

If last "S" is numerical letter : Rohs product

If last "S" is English letter : HF & Rohs product



Package Outline & Packing : SOT-89

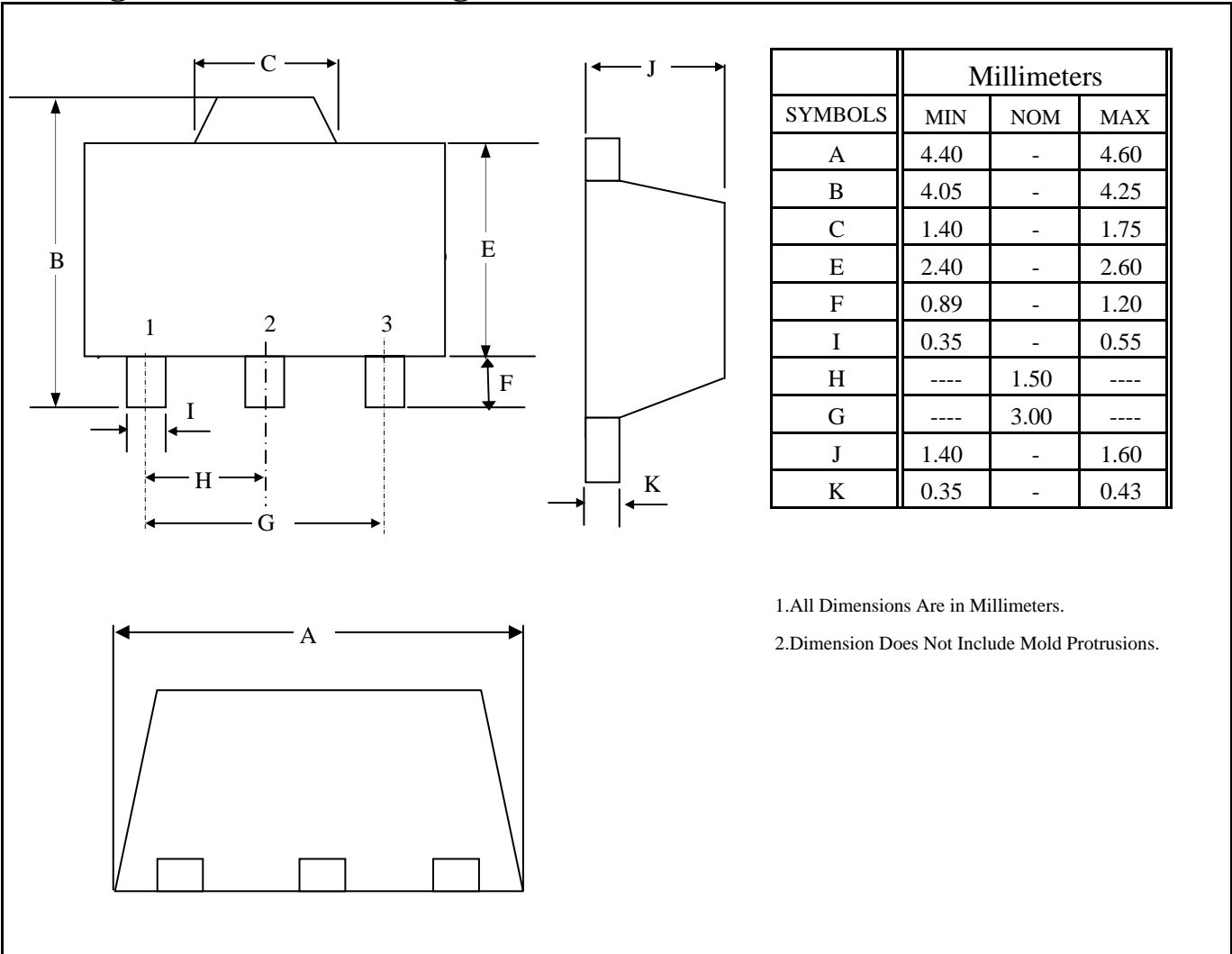

Part Marking Information : SOT-89

